

MİMARİ KATALOG
ARCHITECTURAL CATALOGUE

Alüminyum Kapı Pencere ve Giydirme Cephe Sistemleri
Aluminium Window Doors and Facade Systems

RESCARA



RO73

MİMARİ KATALOG ARCHITECTURAL CATALOGUE

Alüminyum Kapı Pencere ve Giydirme Cephe Sistemleri
Aluminium Window Doors and Facade Systems



Rescara Sistem Detayları
Rescara System Details

RO73

PROFİLLER

PROFILES

01

02

03

04

05

06

07

08

09

10

KASA VE ADAPTÖR PROFİLLERİ
FRAME AND ADAPTER PROFILES

RO73

KOD / CODE	AĞIRLIK (kg/m) / WEIGHT	Jxx cm ⁴	Jyy cm ⁴	L m
RO F 01	1,110	6,599	18,194	6
RO A 01	0,208	---	---	6
RO A 02	0,271	---	---	6
RO A 03	0,234	---	---	6
RO A 05	1,214	---	---	6

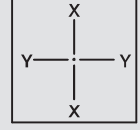

01

02

03

04

05

06

07

08

09

10

RO F 01

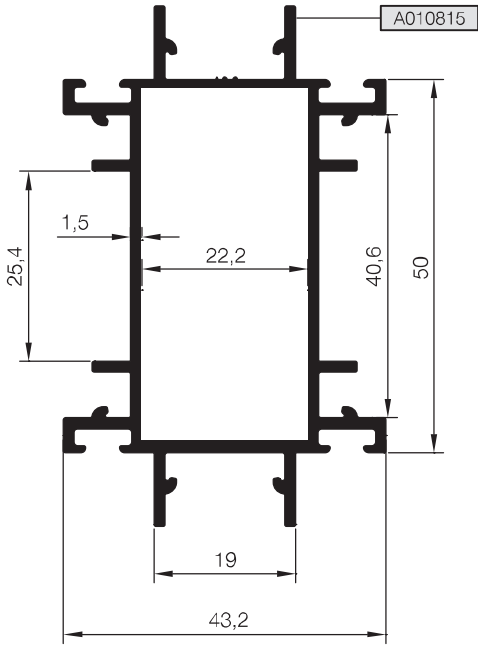

RO A 01

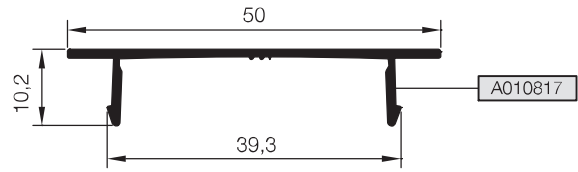

RO A 02

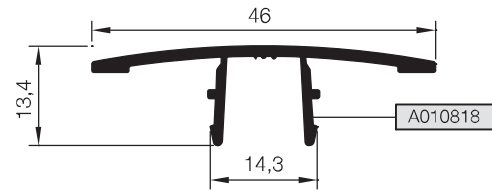

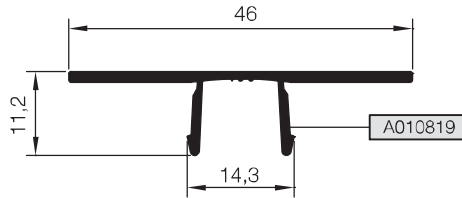

RO A 03

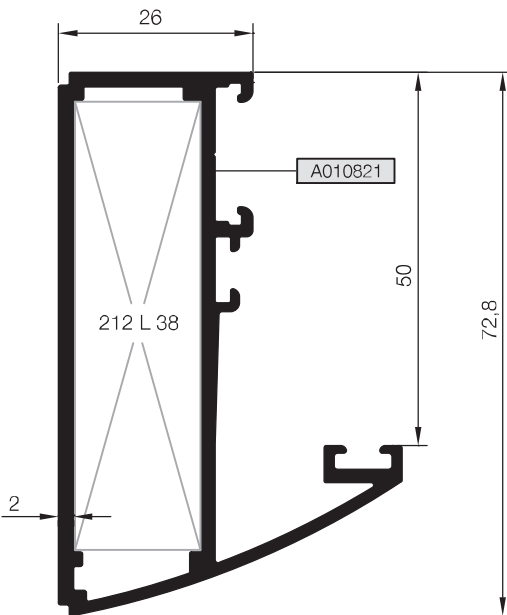

RO A 05



Nr	 L m	KESİM ÖLÇÜSÜ CUTTING SIZE	 AKS. KODU AGS. CODE	
RO A 05	A010821	25 L 38 (A002074)	59,8 mm	212 L 38

ETEK VE ADAPTÖR PROFİLLERİ
KICK PLATE AND ADAPTER PROFILES

RO73

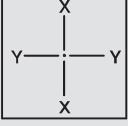
KOD / CODE	AĞIRLIK (kg/m) / WEIGHT	Jxx cm4	Jyy cm4	L m	
RO K 01	2,637	—	—	6	
RO A 04	0,647	—	—	6	

01

02

03

04

05

06

07

08

09

10

RO K 01

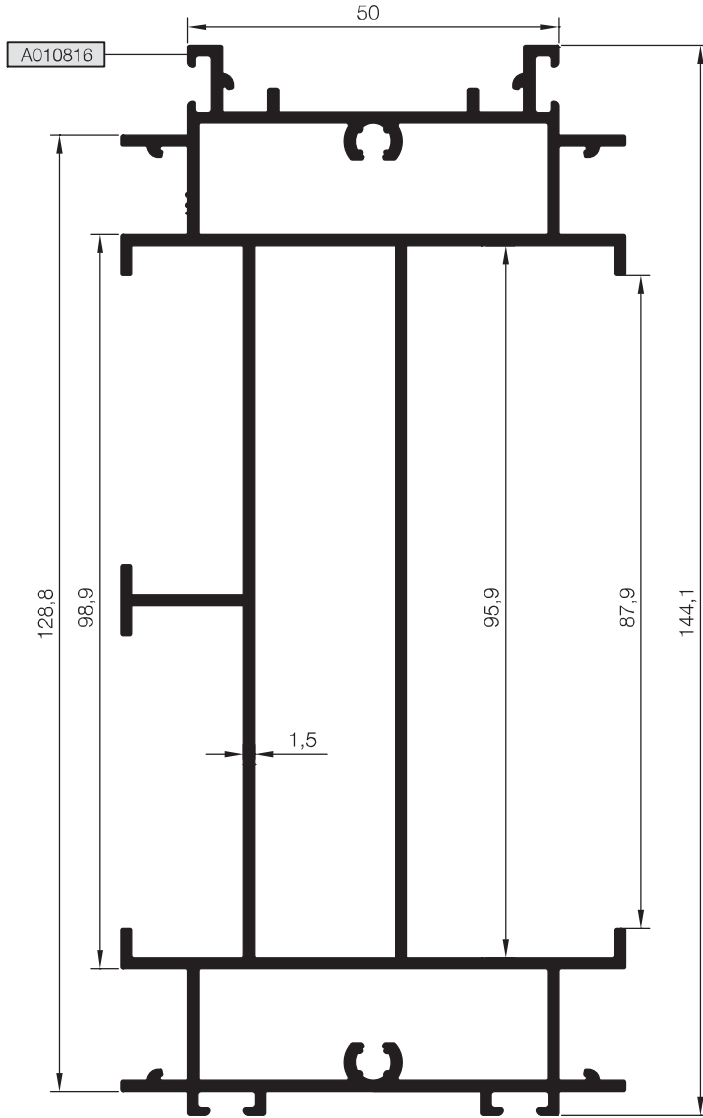

RO A 04

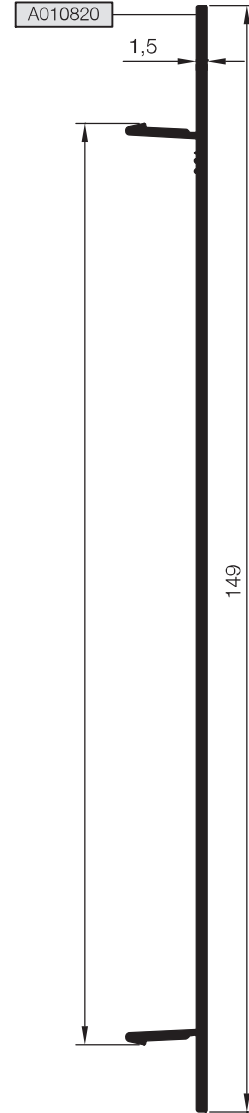



KÖŞE TAKOZLARI

CORNER CLEATS

RO73

TAKOZLAR (CLEATS)

PROFİL KODU (PROFILE CODE)	25 L 38			
FABRİKA KODU (FACTORY CODE)	2074			
AĞIRLIK (WEIGHT)	4,854 kg/m			
ÇİZİM (DRAWING)				

KÖŞE TAKOZLARI (CORNER CLEATS)				
Nr			KESİM ÖLÇÜSÜ CUTTING SIZE	 AKS. KODU ACS. CODE
RO A 05	A010821	25 L 38 (A002074)	59,8 mm	212 L 38

01

02

03

04

05

06

07

08

09

10

MİMARİ KATALOG ARCHITECTURAL CATALOGUE

Alüminyum Kapı Pencere ve Giydirme Cephe Sistemleri
Aluminium Window Doors and Facade Systems



Rescara Sistem Detayları
Rescara System Details

RO73

DETAYLAR

DETAILS

01

02

03

04

05

06

07

08

09

10

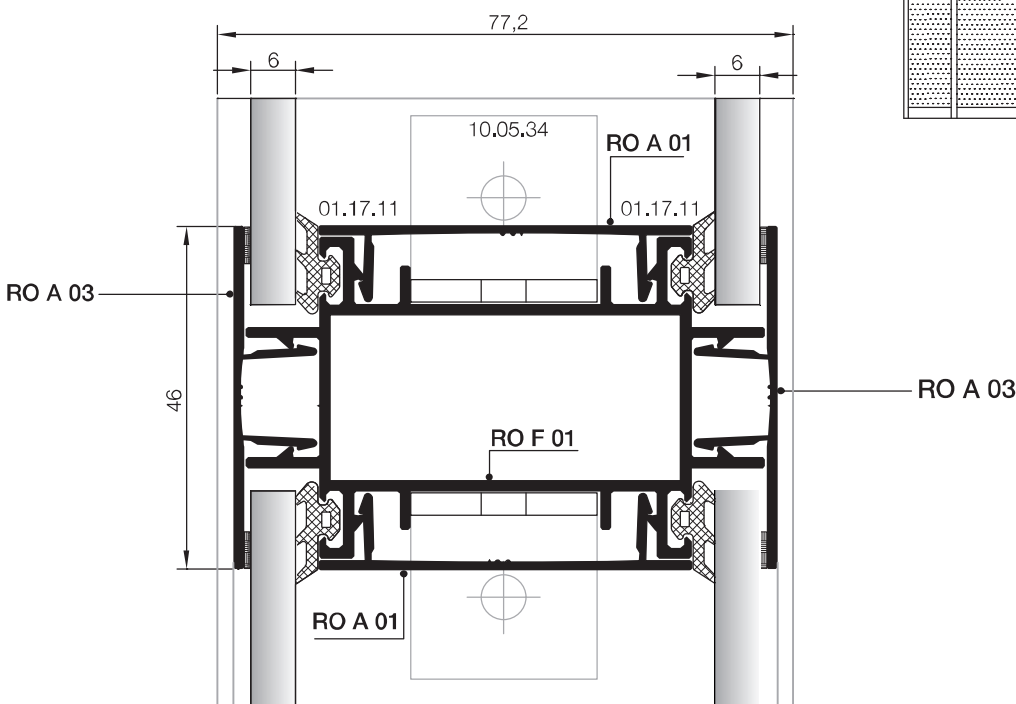
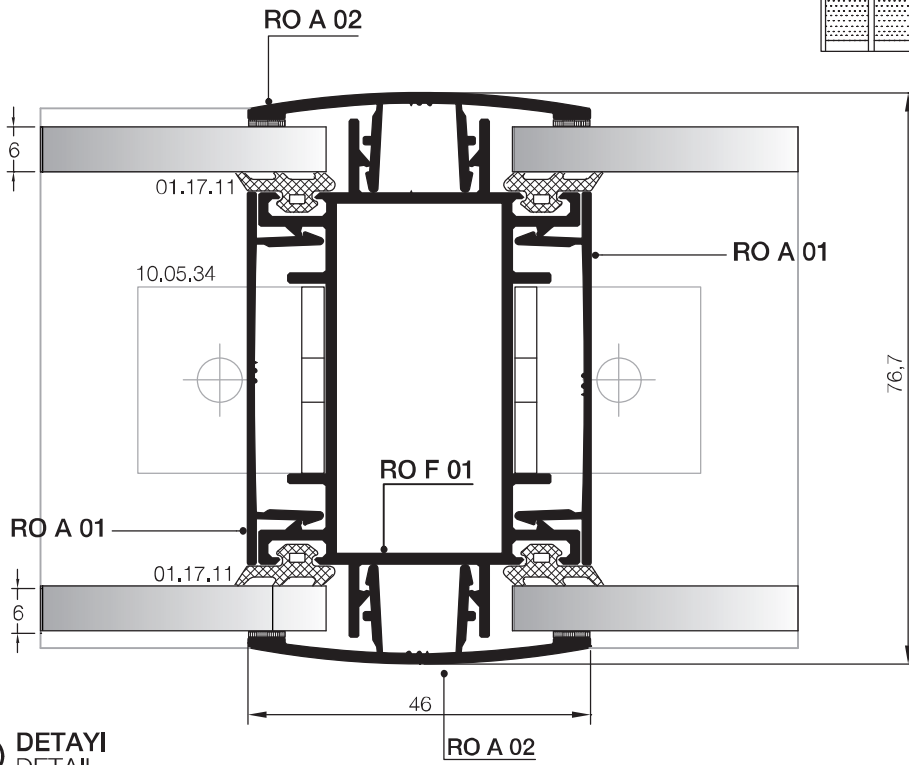

01

02

03

04

05

06

07

08

09

10

01

02

03

04

05

06

07

08

09

10

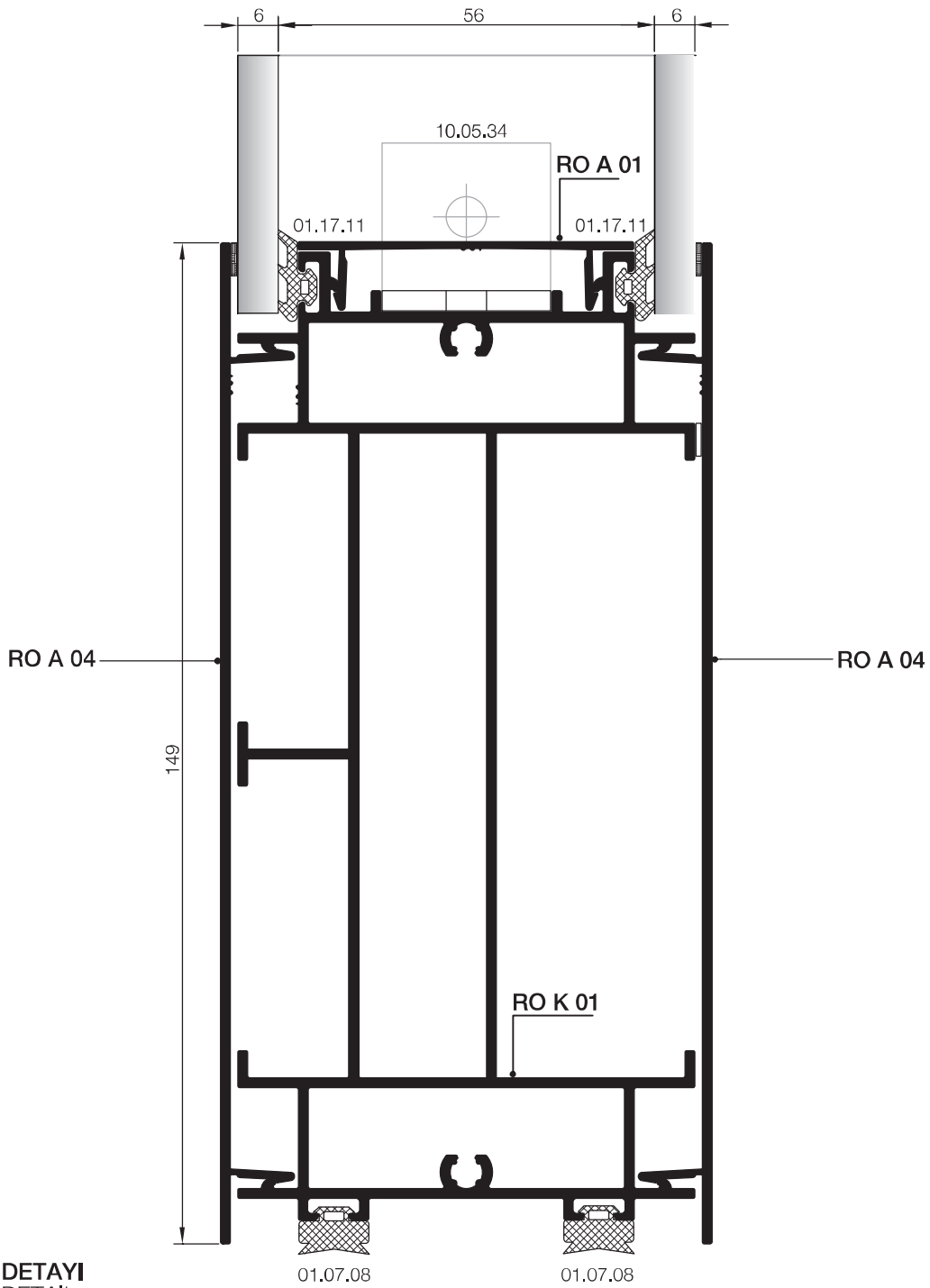
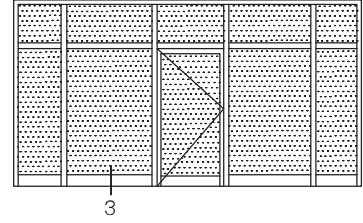

③ DETAYI
DETAIL

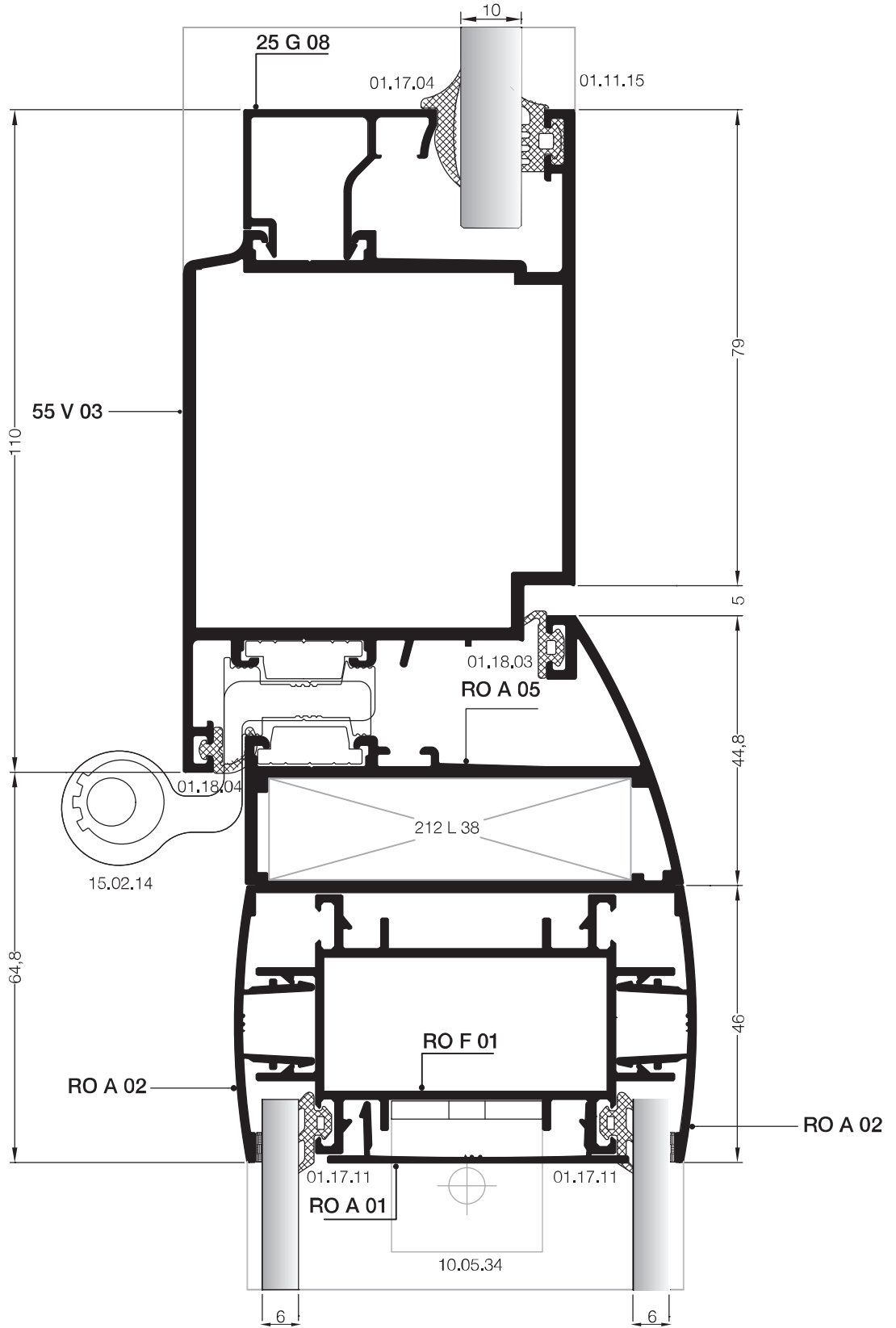
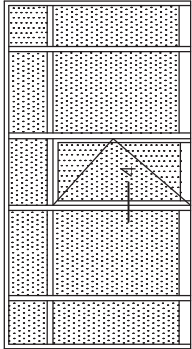

01

02

03

04

05

06

07

08

09

10

④ DETAYI
DETAIL

01

02

03

04

05

06

07

08

09

10

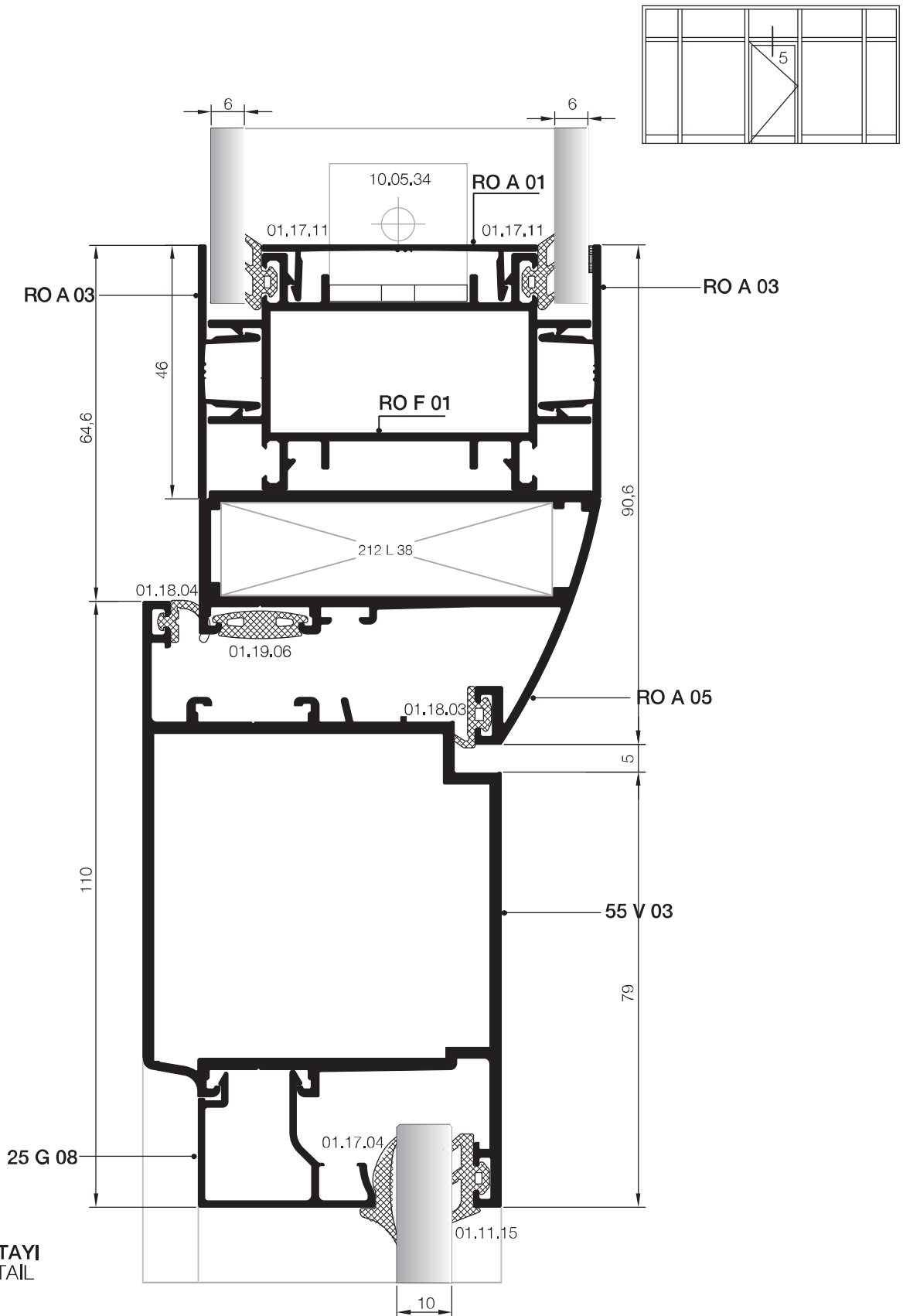

⑤ DETAYI
DETAIL

MİMARİ KATALOG ARCHITECTURAL CATALOGUE

Alüminyum Kapı Pencere ve Giydirme Cephe Sistemleri
Aluminium Window Doors and Facade Systems



Rescara Sistem Detayları
Rescara System Details

RO73

AKSESUARLAR

ACCESSORIES

01

02

03

04

05









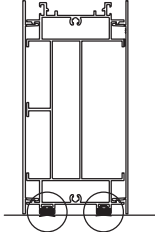

06

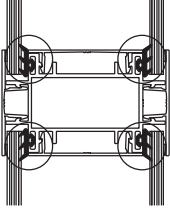
07

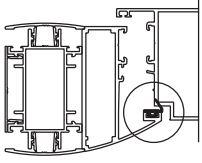
08

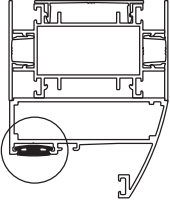
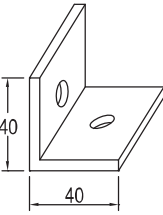
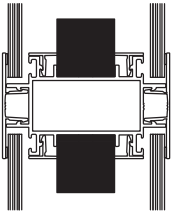
09

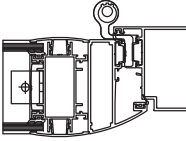
10

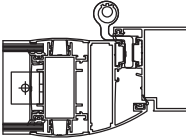
	<p>01.07.08 ETEK ALTI FİTİLİ KICK PLATE GASKET</p> <p>Malzeme / Material : EPDM Ağırlık / Weight : 70 gr/m Paket / Package : 214 m / 15 kg</p>				
	<p>01.17.11 CAM FİTİLİ GLAZING GASKET</p> <p>Malzeme / Material : EPDM Ağırlık / Weight : 235 gr/m Paket / Package : 63,8 m / 15 kg</p>				
	<p>01.18.03 DIŞ BİNI FİTİLİ OUTSIDE ACOUSTICAL GASKET</p> <p>Malzeme / Material : EPDM Ağırlık / Weight : 40 gr/m Paket / Package : 375 m / 15 kg</p>				
	<p>01.19.06 ÇITA KANAL FİTİLİ ADAPTER GASKET</p> <p>Malzeme / Material : EPDM Ağırlık / Weight : 80 gr/m Paket / Package : 185 m / 15 kg</p>				
 <p>40 40</p>	<p>10.05.34 BAĞLANTI PARÇASI CONNECTION PIECE</p> <p>ALÜMİNYUM 25 mm</p>				
	<p>15.02.09 YERLİ KAPI MENTEŞESİ LOCAL HINGE FOR DOORS</p> <p>Renk: Siyah-Beyaz-Gri-Elksal Color: Black-White-Grey-Anodised 85 kg için 3 adet kullanılmaktadır. Should be used for 85 kg. Max. kanat ölçüsü 900 x 2200 Max. vent dimension 900 x 2200</p>				
	<p>15.02.14 GIESSE KAPI MENTEŞESİ GIESSE FOR DOORS</p> <p>Renk: Siyah-Beyaz-Gri-Elksal Color: Black-White-Grey-Anodised 100 kg için 2 adet, 120 kg için 3 adet kullanılmaktadır. / Should be used 2 for 100 kg, 3 for 120 kg. EN 1935</p>				

01

02

03

04

05

06

07

08

09

10

